

MS

ASPIRATORE VENTILATORE CENTRIFUGO
CENTRIFUGAL FAN



GIRANTE A PALE CURVE AVANTI O RADIALI
FORWARD CURVED OR RADIAL BLADES IMPELLER



ALTA PRESSIONE
HIGH PRESSURE

Portata/Flow rate:
45 ÷ 1600 m³/h

Pressione/Pressure:
50 ÷ 300 mm H₂O





MS

ASPIRATORE VENTILATORE CENTRIFUGO CENTRIFUGAL FAN



I ventilatori della serie MS sono indicati per aspirazione di gas di scarico o per il trasporto di materie plastiche.

L'esecuzione standard prevede l'utilizzo di coclee in fusione di alluminio, giranti a pale avanti in lamiera zincata o pale dritte radiali in acciaio al carbonio e l'installazione di motori elettrici a 2 poli.

I fluidi trasportati possono raggiungere una temperatura massima di 80°C in esecuzione standard; nel caso di esecuzioni speciali, sono ammessi valori massimi di 180°C. A richiesta sono disponibili esecuzioni in conformità alla direttiva ATEX (94/9/CE).

MS series blower are suitable for exhaust gas suction sanding or for moving plastic materials.

Standard execution blowers are provided with aluminium cast casings, forwarded blades galvanized or radial blades carbon steel impellers and 2 poles electrical motors.

Transported fluids can reach maximum temperature of 80°C for standard execution; for special executions maximum values of 180°C are allowed. On demand, special execution according to ATEX directive (94/9/CE) are available.



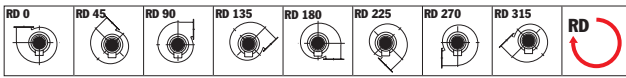
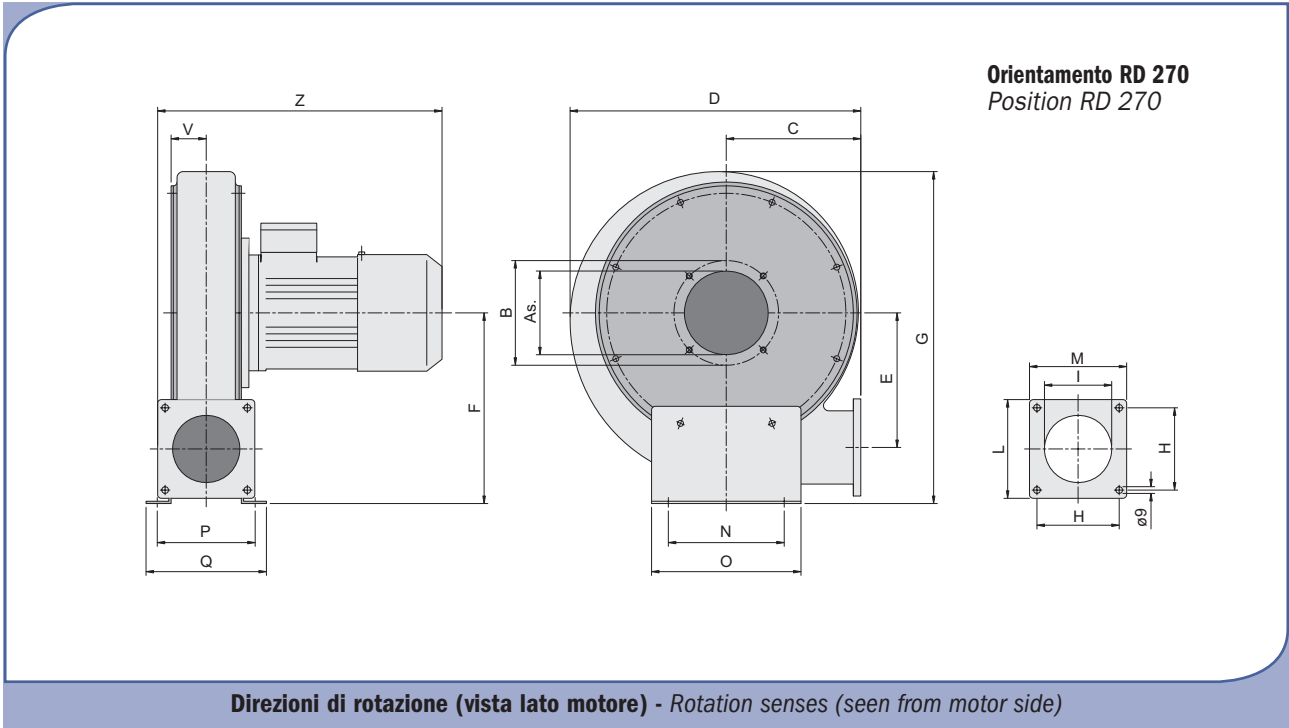

Rotazione oraria - Clockwise rotation sense

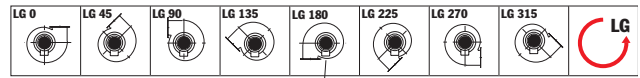

Rotazione anti-oraria - Anti-Clockwise rotation sense

Peso ventilatore in Kgf (completo di motore) - Weight of ventilator (complete with motor)

Nota: quota Z indicativa - Note: 'Z' quote indicative

TIPO - TYPE		kW inst.	PESO WEIGHT	VENTILATORE FAN																
VENTILATORE FAN	MOTORE MOTOR			kgf	As.	B	C	D	E	F	G	H	I	L	M	N	O	P	Q	V
MS 22	63 A2	0,18	9	90	105	135	288	130	188	328	68	66	108	108	140	170	120	151	44	282
MS 25	71 A2	0,37	12	112	140	160	350	164	235	392	95	83	123	120	155	200	117	147	44	293
MS 28	71 B2	0,55	17	112	140	182	395	182	255	447	110	9	132	130	155	200	131	161	48	303
MS 30	80 A2	0,75	20	112	140	182	395	182	255	447	110	9	132	130	155	200	131	161	48	327
MS 35	90 S2	1,5	25	112	195	226	475	217	292	517	115	105	145	145	180	220	146	186	53	435
MS 36	90 S2	1,5	28	112	140	250	523	230	320	577	120	120	164	162	200	240	141	191	50	372
MS 40	90 L2	2,2	31	112	140	250	523	230	320	577	120	120	164	162	200	240	141	191	50	372

DIRETTAMENTE ACCOPPIATI CON MOTORE A 2 POLI

DIRECT CONNECTION FOR 2 POLES MOTORS

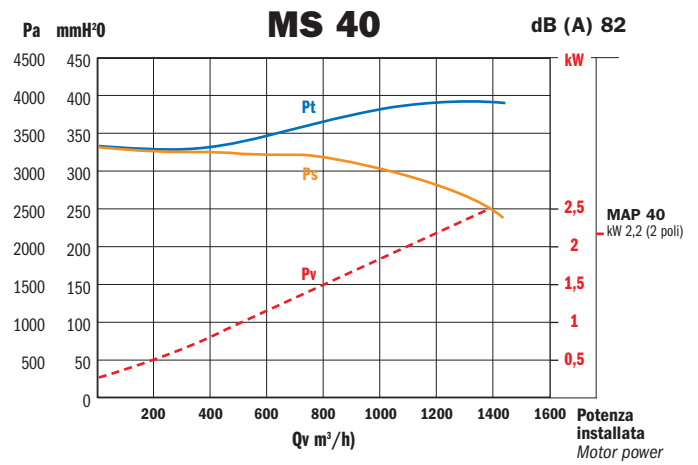
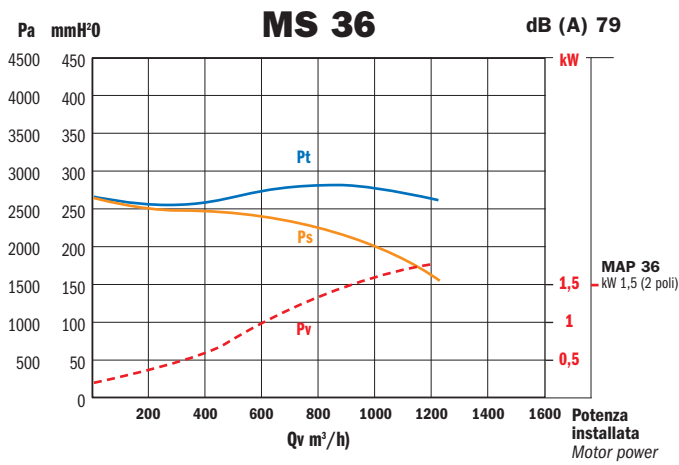
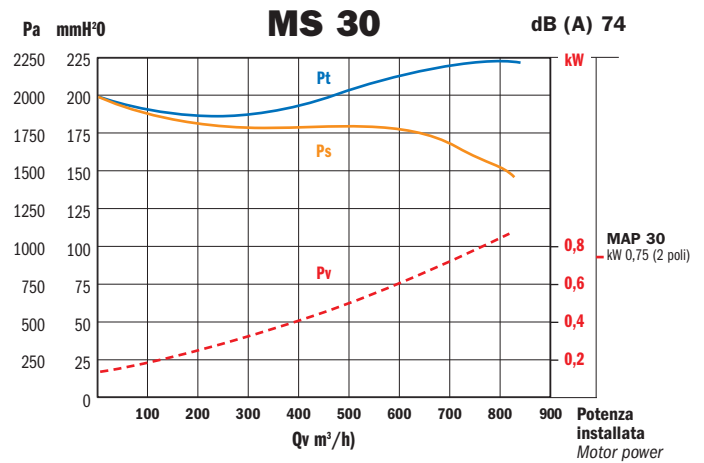
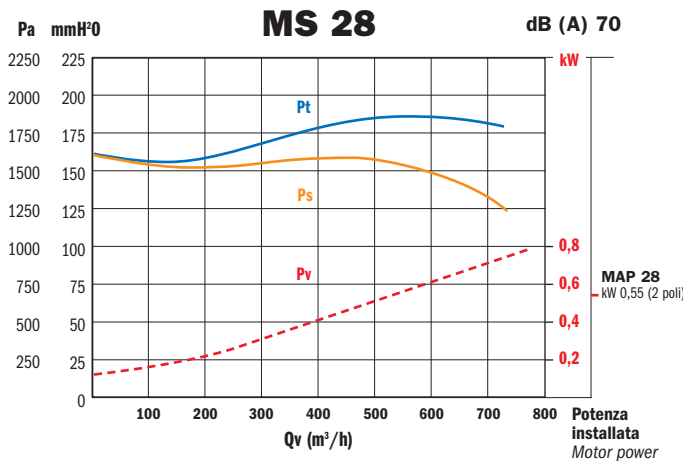
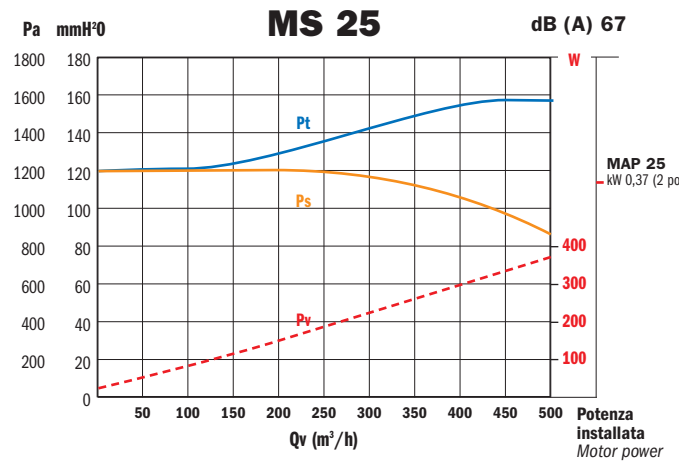
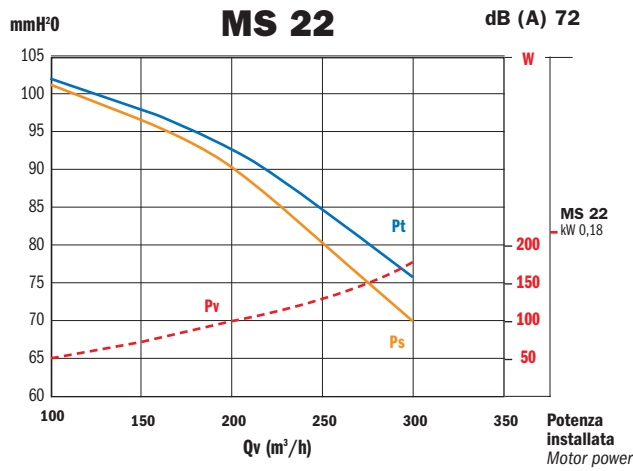

Valori riferiti a: / Datas referring to: T=15°C; P=1 atm

— Pt= Pressione totale - Total pressure — Ps= Pressione statica - Statical pressure - - - Pv= Potenza assorbita - Absorbed power

DIRETTAMENTE ACCOPPIATI CON MOTORE A 2 POLI

DIRECT CONNECTION FOR 2 POLES MOTORS

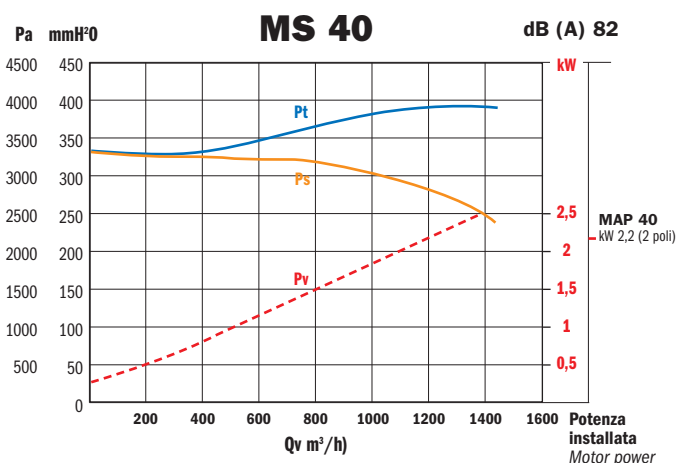
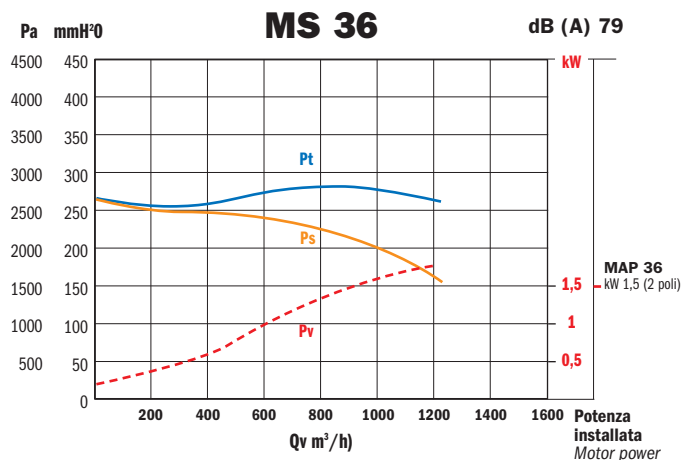
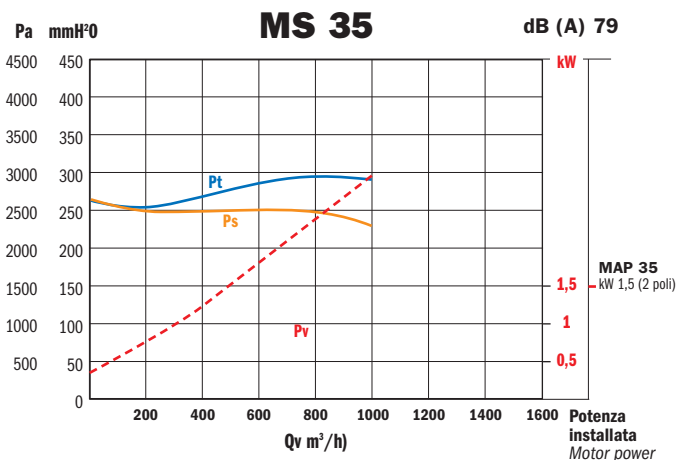

Valori riferiti a: / Datas referring to: T=15°C; P=1 atm

— Pt= Pressione totale - Total pressure — Ps= Pressione statica - Statical pressure - - - Pv= Potenza assorbita - Absorbed power